



Tempest GP27Q (GP27-FQS)
Cooler Master 27" Gaming Monitor

User Manual

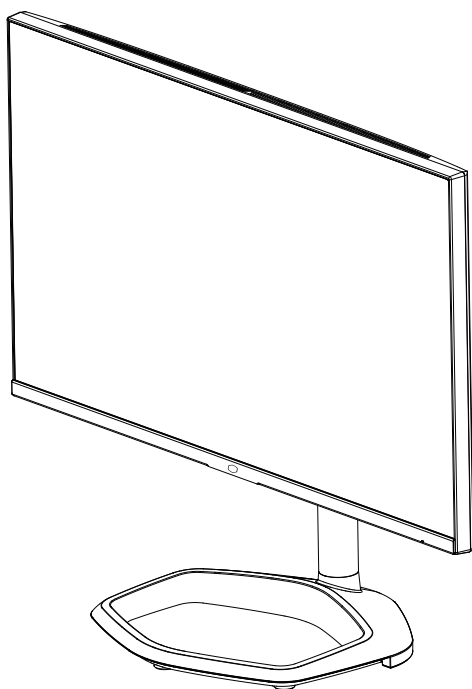

Table of Contents

Requirements and Safety Notice.....	1
Important Safety Instructions.....	3
Package Contents	4
Installing the Monitor Stand and Base.....	5
Adjusting the Monitor.....	7
Wall Mount Installation Instructions	8
External Control Buttons.....	9
Main Menu.....	10
[Input Select].....	10
[Picture Setting]	10
[Color Adjust]	11
[Gaming Setup].....	11
[Advanced].....	12
[System].....	12
Specifications	13
Supported Timing	14
[PC Timing].....	14
[Video Timing].....	18
Product Outline Dimensions.....	19

Requirements and Safety Notice

FCC Safety Notice

This product has been tested and determined to be meeting the limits for a Class B digital device and in compliance with Part 15 of the FCC Regulations. These requirements are set to reasonably protect the home installation environment from hazardous interference. This product will generate, use and emit radio frequency energy. Failure to install and use it as instructed may cause hazardous interference to radio communication. However, we cannot guarantee zero interference for certain installation methods. If this product has caused hazardous interference to radio or TV reception (turn on or turn off this product to for confirmation), the user may try to make adjustment with the following methods:

- Re-adjust the angle and position of the reception antenna.
- Increase the separation between the device and receiver.
- Do not use the power sockets of the device and receiver together.
- If assistance is needed, contact the distributor or a professional radio/TV technician.

CE Compliance Statement

Cooler Master Technology Inc. hereby declares that the monitor conforms to the following key standards and other related provisions:

EMC Directive 2014/30/EU, Low Voltage Directive 2014/35/EU, RoHS Directive 2011/65/EU and Directive 2009/125/EC establishing a framework for the setting of eco-design requirements for energy-related products.

Remarks:

To prevent damage of the monitor, do not lift the monitor from the support base.

Remarks: Shielded cables

To comply with the EMC requirements, a shielded cable must be used for connection between this product and any other computer device.

Remarks:

The monitor is exclusively used in the video and image display of information acquired from electronic devices.

Remarks: Peripherals

Only a peripheral device (I/O device, terminal, printer, etc.) that has been certified and met the Class B limits can be sold together with this product.

If this product is used together with any other uncertified peripheral device, it may cause interference to radio and TV reception.

Warning

Any change or modification not approved by the original manufacturer may lead to the user losing the right to operate this product. Such authorization is given by the Federal Communications Commission.

Requirements for Use

This product meets the limits under Part 15 of the FCC Regulations. Operation is subject to the following two conditions: (1) this product may not cause harmful interference, and (2) this product must accept any signal interference received, including interference that may cause undesired operation.

The following local Manufacturer/Importer is responsible for this declaration.

<p>Product Name: LCD Monitor Model No: GP27-FQS Company Name: North America - CMI USA, Inc. Address: 1 N Indian Hill Blvd Suite 200, Claremont, CA 91711, USA Contact: Cooler Master Representative Phone: +1-888-624-5099</p>
--

Remarks: Canadian users

This Class B digital device complies with Canadian ICES-003 specifications.

Remarque à l'intention des utilisateurs canadiens

Cet appareil numérique de la classe B est conforme à la norme NMB-003 du Canada

Disposal of Waste Equipment by Home Users in EU



If this symbol appears on a product and its package, it indicates that the product cannot be disposed of together with other household waste. You have to deliver the waste equipment to a designated recycling center for recycling of waste electrical and electronic equipment. Proper sorting and recycling of resources during the disposal of waste equipment is helpful for protecting natural resources and ensuring that resource recycling can protect human health and environment. For detailed information about recycling centers where waste equipment is disposed of, contact the local municipal office, cleaning service or the store where the purchased product is found.

电子电气产品有害物质限制使用标识要求

本产品有害物质的名称及含量标识如下表：

部件名称	有害物质					
	铅 (Pb)	汞 (Hg)	镉 (Cd)	六价铬 (Cr (VI))	多溴联苯 (PBB)	多溴联苯醚 (PBDE)
外壳	○	○	○	○	○	○
电路板组件*	×	○	○	○	○	○
电源线/适配器	×	○	○	○	○	○
外部信号连接线	×	○	○	○	○	○
液晶面板	×	○	○	○	○	○

本表格依据 SJ/T 11364 的规定编制。

*：电路板组件包括印刷电路板及其构成的零部件，如电阻、电容、集成电路、连接器等

○：表示该有害物质在该部件所有均质材料中的含量均在 GB/T26572 规定的限量要求以下。

×：表示该有害物质至少在该部件的某一均质材料中的含量超出 GB/T26572 规定的限量要求。

限用物質含有情況標示聲明書

單元 Unit	限用物質及其化學符號 Restricted substances and its chemical symbols					
	鉛 Lead (Pb)	汞 Mercury (Hg)	鎘 Cadmium (Cd)	六價鉻 Hexavalent chromium (Cr ⁺⁶)	多溴聯苯 Polybrominated biphenyls (PBB)	多溴二苯醚 Polybrominated diphenyl ethers (PBDE)
支架/外殼	○	○	○	○	○	○
印刷電路板	—	○	○	○	○	○
玻璃面板	—	○	○	○	○	○
電纜/電線/連接線	—	○	○	○	○	○
電源設備/外接電源供應器	—	○	○	○	○	○

備考1. “超出0.1 wt %” 及 “超出0.01 wt %” 係指限用物質之百分比含量超出百分比含量基準值。

備考2. “○” 係指該項限用物質之百分比含量未超出百分比含量基準值。

備考3. “—” 係指該項限用物質為排除項目。

Important Safety Instructions

Please read the following instructions carefully.

1. To clean the LCD monitor screen:
 - Turn off the LCD monitor and unplug the power cord.
 - Spray a non-solvent cleaning solution onto a rag and clean the screen gently.
2. Do not place the LCD monitor near a window. Exposing the monitor to rain, moisture or sunlight can severely damage it.
3. Do not apply pressure to the LCD screen. Excessive pressure may cause permanent damage to the display.
4. Do not remove the cover or other things to repair the device yourself.
An authorized technician should perform servicing of any nature
5. Store the LCD monitor in a room with a temperature of -20 to 60 °C (-4 to 140 °F).
Storing the LCD monitor outside this range may result in permanent damage.
6. Immediately unplug your monitor and call an authorized technician if any of the following circumstances occur:
 - Monitor to PC signal cable is frayed or damaged.
 - Liquid spills onto the LCD monitor or the monitor is exposed to rain.
 - The LCD monitor or case is damaged.

Package Contents

A



Monitor

B

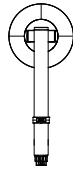

Stand

C

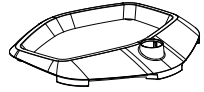

Base

D

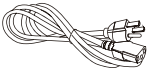

Power cord (Optional)

E

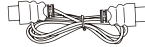

HDMI cable (Optional)

F



DP cable (Optional)

G



Cable clip
(Used for fixing cables on the back of the stand)

H



Base screw
(Used for installing the base and stand)

I

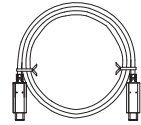

Type C cable (Optional)

J

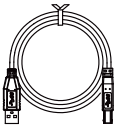

USB Type A to B cable (Optional)
(PC and Monitor data transmission)

K

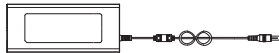

Adapter

Installing the Monitor Stand and Base

1

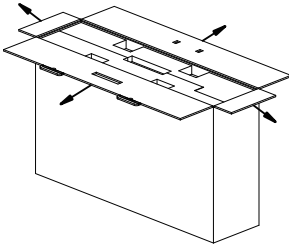

2

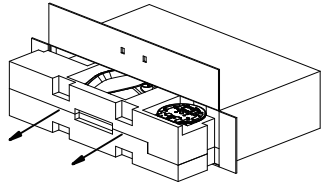

3

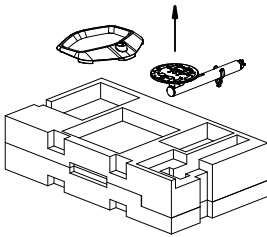

4

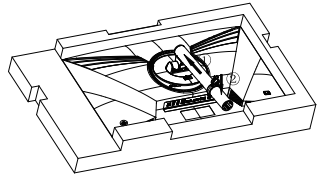

5

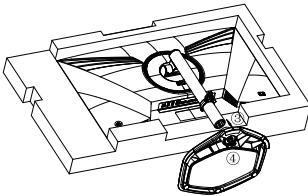

6

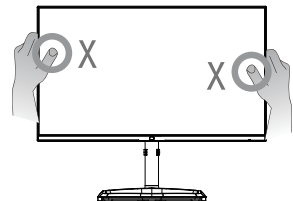
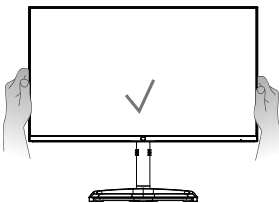

7

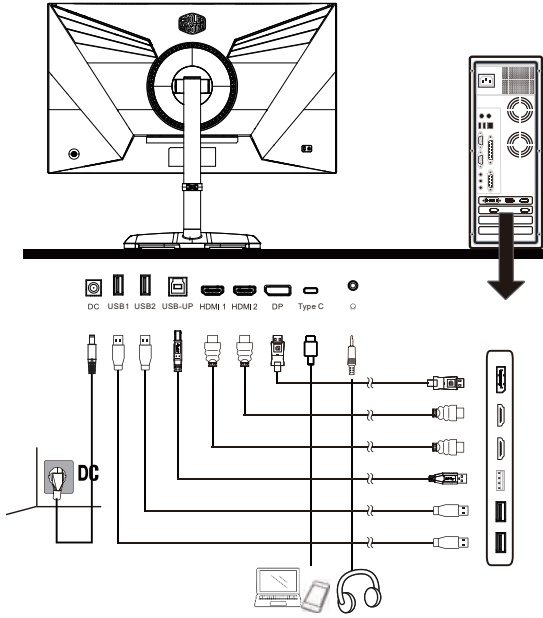

8

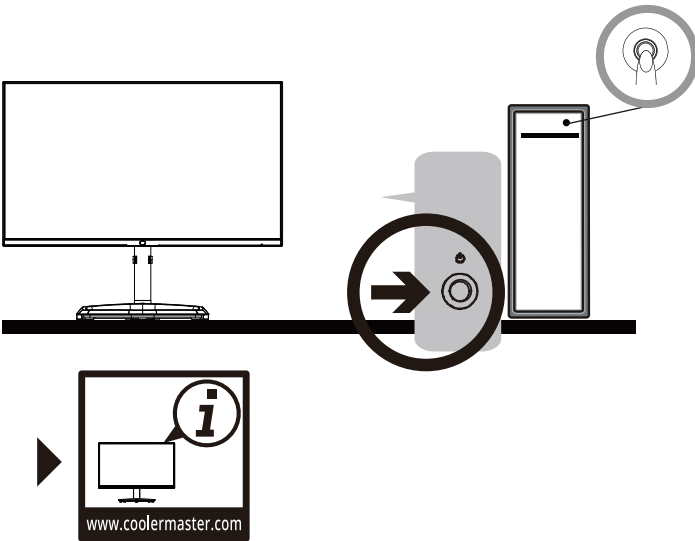

Adjusting the Monitor

- For the best results, it is recommended to look directly at the front of the monitor and make any adjusts as necessary.
- Ensure that the monitor is mounted upright on the stand base.
- When adjusting the monitor viewing angles, avoid touching the screen and hold the stand in order to prevent it from falling over.

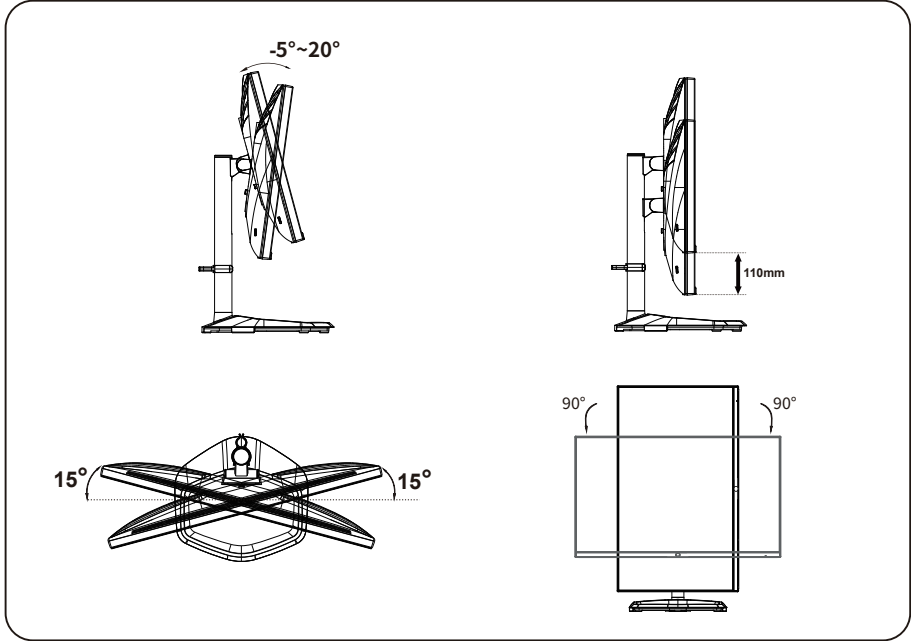

Wall Mount Installation Instructions

1

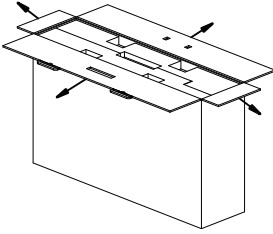

2

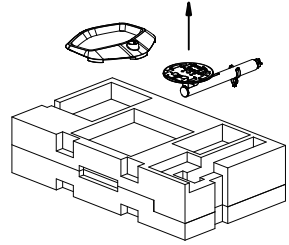

3

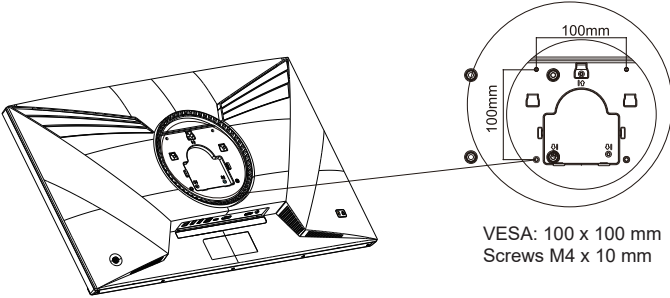

4

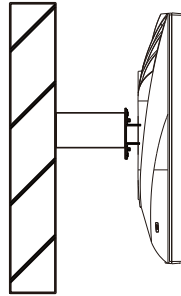
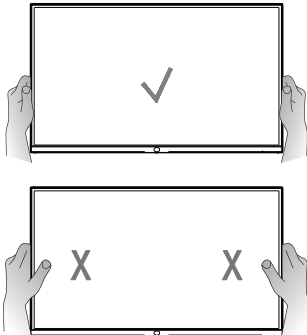

External Control Buttons

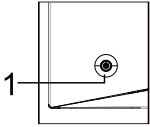

① Menu/Navi/OK button

Short press to turn on the monitor and Long press to turn off.

When the OSD menu is activated, pull up/down/left/right the button to adjust the settings you need.

When finished, you can pull the Button Back to return to the previous level or use the Button Exit to close the OSD menu.

Remarks: Power indicator;

Green = ON;

Orange = Power Saving.

The OSD Menu and OSD Quick-Menu Symbol explanations and their functional uses are stated below.

The following content is for general reference only. Actual product specifications may vary.

Button descriptions

Initial state:

Joystick up	Select the signal source.
Joystick down	KVM
Joystick left	Assist in the game.
Joystick right	Select the picture mode.
Joystick press	Short press to turn on the monitor or open the menu. Long press for 3 seconds to turn off the monitor.

Enter the OSD menu:

Joystick up	Move up from the same level menu or increase the value.
Joystick down	Move down from the same level menu or decrease the value.
Joystick left	Return to the previous menu.
Joystick right	Go to the next menu.
Joystick press	Short press to close the menu. Long press for 3 seconds to turn off the monitor.

	Move up, down, left, or right from the same level menu.
	Return to the previous menu.
	Go to the next menu.

Main Menu

[Input Select]

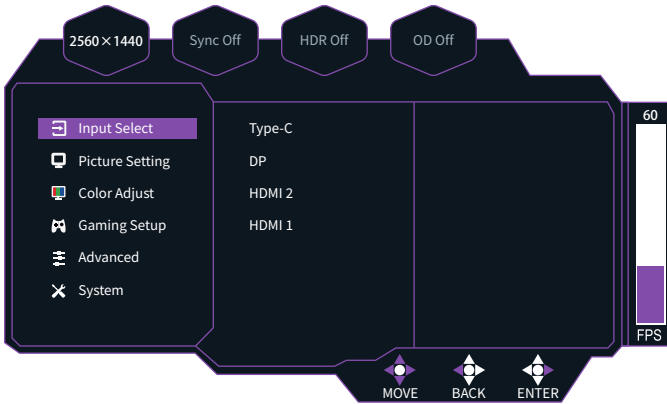

- Enter the Input Select menu to switch the input signal.
 - **Type-C:** Maximum input signal 2560×1440@165 Hz.
 - **DP:** Maximum input signal 2560×1440@165 Hz.
 - **HDMI 1, 2:** Maximum input signal 2560×1440@144 Hz.

[Picture Setting]

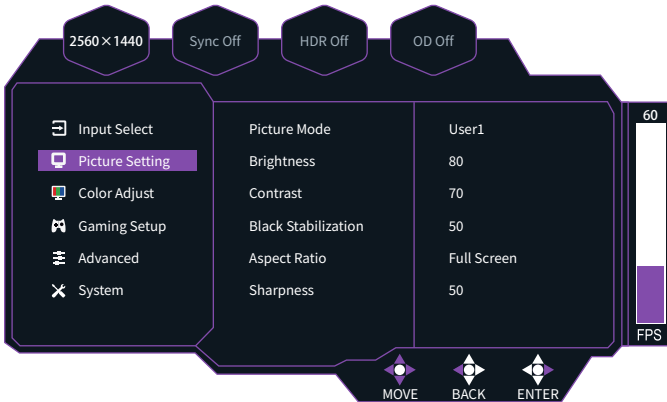

- Enter the Picture Setting menu to adjust the picture mode.
 - **Picture Mode:** Experience different picture modes.
 - **Brightness:** Adjust the backlight brightness from 0 and 100.
 - **Contrast:** Adjust the contrast from 0 and 100.
 - **Black Stabilization:** Illuminate dark areas without overexposing brighter areas. The value ranges from 0 to 100.
 - **Aspect Ratio:** Adjust the aspect ratio of the screen.
 - **Sharpness:** Adjust the sharpness from 0 and 100.

[Color Adjust]

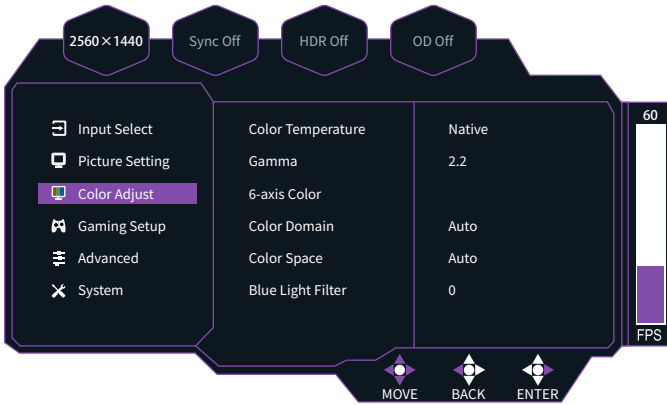

- Enter the Color Adjust menu to adjust the color mode.
 - **Color Temperature:** Select Cool, Bluish, Native, Warm, or User Color.
 - **Gamma:** Set the gamma curve to 1.8, 2.0, 2.2, 2.4, or 2.6.
 - **6-axis Color:** Adjust the hue and saturation.
 - **Color Domain:** Select Auto Mode, RGB Mode, or YUV Mode.
 - **Color Space:** Switch the color space among Auto, sRGB, Adobe RGB, DCI-P3, and BT.2020.
 - **Blue Light Filter:** Protect your eyes using low blue light technology to reduce blue light emission from the monitor. The value ranges from 0 and 100.

[Gaming Setup]

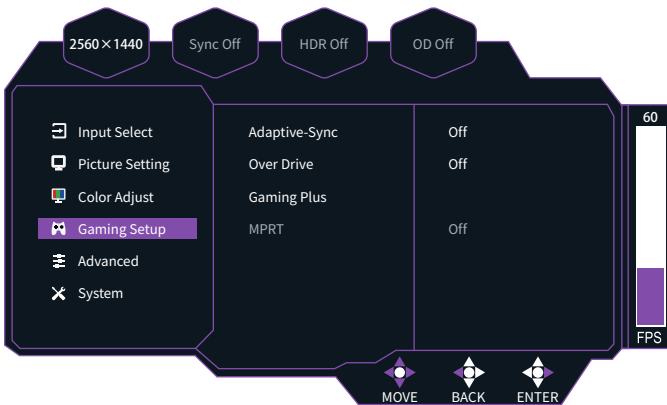

- Enter the Game Setup menu to adjust the game mode.
 - **Adaptive-Sync:** Turn it on or off.
 - **Over Drive:** Select the Off, Normal, Advanced, Ultra Fast, Dynamic or User mode to disable or accelerate the response time.
 - **Gaming Plus:** Gaming plus functions including Timer, Crosshair, and FPS Counter.

[Advanced]

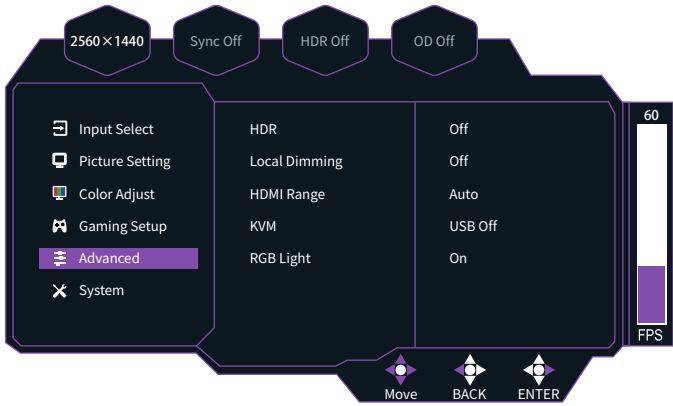

- Enter the Advanced Setting menu to select the advanced mode.
 - **HDR:** Turn it off or allow it adjust automatically.
 - **Local Dimming:** Select the Off, Low, Medium, or High mode.
 - **HDMI Range:** Select Auto, Full Range, or Limited Range.
 - **KVM:** Select the **KVM** access.
 - **RGB Light:** Turn it on or off.

[System]

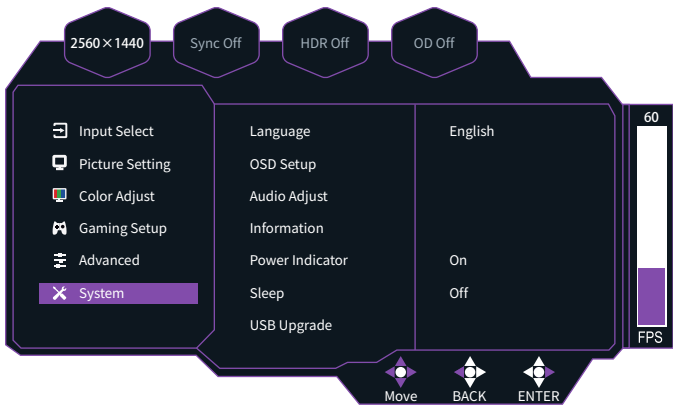

- Enter the Setup Menu to select your preferred settings.
 - **Language:** Set the language to English, Simplified Chinese, Traditional Chinese, Korean, Japanese, Spanish, French, German, Italian, Vietnamese, Russian, or Finnish.
 - **OSD Setup:** Adjust the OSD menu display position.
 - **Audio Adjust:** Select Mute or adjust the volume from 0 and 100.
 - **Information:** View basic information about the device such as Resolution, Frame Rate, HDR, Adaptive-Sync, H. Frequency, and Pixel Clock.
 - **Power Indicator:** Turn it on or off.
 - **Sleep:** Select the idle time before the monitor enters Sleep mode. The value can be 30 Minutes, 45 Minutes, or 60 Minutes.
 - **USB Upgrade:** Used for later maintenance or updates.
 - **Recall:** Restore the settings to default values.

Specifications

LCD panel	Size	27"
	Pixel pitch	0.2331(H) x 0.2331(V)mm
	Brightness	600 nits (Typ.)
	Contrast	1000:1 (Typ.)
	Viewing angle	178°(Horizontal) 178°(Vertical)
	Response time	1 ms**
Display colors		1.07 billion colors
Maximum display frequency (Resolution H * V/Fv)		2560×1440@144 Hz (HDMI) 2560×1440@165 Hz (DP & Type-C)
Power consumption	Power On	39.5 W ***
	Standby	≤ 0.5 W
	Power off	≤ 0.3 W
Input/output connector		HDMI×2 DP×1 Type-C×1 (PD 5V = 3A 9V = 3A 12V = 3A 15V = 3A 20V = 4.5A) USB-A×2 USB-B×1 Earphone jack×1
Input video signal		HDMI signal (HDMI models only) DP signal (DP models only) TYPE C signal (TYPE C models only);
Speakers		3 W×2
Adapter		24 V --- 10 A
Environmental conditions		Operating temperature: 0°C to 40°C Storage temperature: -20°C to 60°C Operating humidity: 20% to 85%
Monitor dimensions (W×D×H)		617.8×273.7×525.9 mm (with arm/base) 617.8×64.8×364.2 mm (without arm/base)
Box dimensions (W×D×H)		830×215×500 mm
Weight (Net)		5.1 kg/Unit (with arm/base) 3.5 kg/Unit (without arm/base)
Machine specifications		Tilt: -5° to 20° Horizontal rotation: -15° to 15° Vertical rotation: 0° ± 90° Height: 0 to 110 mm
Compliance		
 <p>The image shows a row of compliance logos: FCC, RoHS, SDOE, R38755, HDMI (High-Definition Multimedia Interface), Raccolta Carta (Recycling), and a recycling symbol with '20 PAP' (Paper).</p>		
<p>The terms HDMI, HDMI High-Definition Multimedia Interface, HDMI Trade Dress and the HDMI Logos are trademarks or registered trademarks of HDMI Licensing Administrator, Inc.</p>		

*Specifications are subject to change without notice.

**The screen may flicker and other uncomfortable phenomena when the Motion Clearness function is enabled.

***Measure a screen brightness of 200 nits without audio/USB/Card reader connection.

If you have any question regarding use of the monitor, please visit:

<https://www.coolermaster.com/warranty>

Supported Timing

[PC Timing]

Mode	Resolution	H. Frequency (kHz)	Frame Rate (Hz)	Pixel Clock (MHz)	Port			
					HDMI1 Input	HDMI2 Input	DP1 Input	Type-C Input
VGA	640×480@59Hz	31.463	59.9286	25.17	○	○	○	○
	640×480@60Hz	31.5	60	25.2	○	○	×	×
		27.788	59.9286	25.17	×	×	○	○
	640×480@67Hz	33.438	66.6086	26.75	×	×	○	○
	640×480@72Hz	37.861	72.8088	31.5	×	×	○	○
	640×480@75Hz	37.5	75	31.5	○	○	○	○
	640×480@100Hz	148.099	99.9995	402.83	×	×	○	○
		182.997	119.998	497.75	○	○	×	×
	640×480@120Hz	178.784	119.989	486.29	×	×	○	○
		213.264	144	580.08	○	○	○	○
	640×480@144Hz	244.364	164.999	664.67	×	×	○	○
	640×480@165Hz	244.364	164.999	664.67	×	×	○	○
	720×480@59Hz	31.469	59.9401	27	○	○	○	○
	720×480@60Hz	31.492	59.9845	27.02	○	○	○	○
	720×480@100Hz	148.099	99.9995	402.83	×	×	○	○
		134.864	119.998	497.75	○	○	×	×
	720×480@120Hz	178.784	119.989	486.29	×	×	○	○
		213.264	144	580.08	○	○	○	○
	720×480@144Hz	244.364	164.999	664.67	×	×	○	○
	720×480@165Hz	244.364	164.999	664.67	×	×	○	○
720×576@50Hz	31.25	50	27	○	○	×	×	
720×576@60Hz	88.787	59.9506	241.5	○	○	×	×	
720×576@120Hz	182.997	119.998	497.75	○	○	×	×	
720×576@144Hz	213.264	144	580.08	○	○	×	×	
SXGA	1280×1024@60Hz	63.981	60.0197	108	○	○	○	○
	1280×1024@75Hz	79.976	75.0247	135	○	○	○	○
	1280×1024@100Hz	148.099	99.9995	402.83	×	×	○	○
		182.997	119.998	497.75	○	○	×	×
	1280×1024@120Hz	178.784	119.989	486.29	×	×	○	○
		213.264	144	580.08	○	○	○	○
	1280×1024@144Hz	244.364	164.999	664.67	×	×	○	○
	1280×1024@165Hz	244.364	164.999	664.67	×	×	○	○
	1366×768@60Hz	55.935	59.8874	106.5	○	○	○	○
	1366×768@100Hz	148.099	99.9995	402.83	×	×	○	○
		182.997	119.998	497.75	○	○	×	×
	1366×768@120Hz	178.784	119.989	486.29	×	×	○	○
		213.264	144	580.08	○	○	○	○
1366×768@144Hz	244.364	164.999	664.67	×	×	○	○	
1366×768@165Hz	244.364	164.999	664.67	×	×	○	○	

Mode	Resolution	H. Frequency (kHz)	Frame Rate (Hz)	Pixel Clock (MHz)	Port			
					HDMI1 Input	HDMI2 Input	DP1 Input	Type-C Input
VESA	1152×864@60Hz	88.787	95.9506	241.5	×	×	○	○
	1152×864@75Hz	67.5	75	108	×	×	○	○
	1152×864@100Hz	148.099	99.9995	402.83	×	×	○	○
	1152×864@120Hz	178.784	119.989	486.29	×	×	○	○
	1152×864@144Hz	213.264	144	580.08	×	×	○	○
	1152×864@165Hz	244.364	164.999	664.67	×	×	○	○
	1152×872@60Hz	88.787	59.9506	241.5	×	×	○	○
	1152×872@75Hz	68.359	74.8734	105	×	×	○	○
	1152×872@100Hz	148.099	99.9995	402.83	×	×	○	○
	1152×872@120Hz	178.784	119.989	486.29	×	×	○	○
	1152×872@144Hz	213.264	144	580.08	×	×	○	○
	1152×872@165Hz	244.364	164.999	664.67	×	×	○	○
	1280×720@50Hz	37.5	50	74.25	○	○	○	○
	1280×720@59Hz	44.952	59.9354	74.17	○	○	○	○
	1280×720@60Hz	45	60	74.25	○	○	○	○
	1280×720@100Hz	148.099	99.9995	402.83	×	×	○	○
	1280×720@120Hz	182.997	119.998	497.75	○	○	×	×
		178.784	119.989	486.29	×	×	○	○
	1280×720@144Hz	213.264	144	580.08	○	○	○	○
	1280×720@165Hz	244.364	164.999	664.67	×	×	○	○
1280×960@60Hz	60	60	108	×	×	○	○	
1280×960@100Hz	148.099	99.9995	402.83	×	×	○	○	
1280×960@120Hz	178.784	119.989	486.29	×	×	○	○	
1280×960@144Hz	213.264	144	580.08	×	×	○	○	
1280×960@165Hz	244.364	164.999	664.67	×	×	○	○	
MAC	832×624@60Hz	88.787	95.9506	241.5	×	×	○	○
	832×624@75Hz	48.953	74.8364	53.25	×	×	○	○
	832×624@100Hz	148.099	99.9995	402.83	×	×	○	○
	832×624@120Hz	178.784	119.989	486.29	×	×	○	○
	832×624@144Hz	213.264	144	580.08	×	×	○	○
	832×624@165Hz	244.364	164.999	664.67	×	×	○	○
	1024×768@60Hz	48.363	60.0038	65	○	○	○	○
	1024×768@70Hz	56.476	70.0694	75	×	×	○	○
	1024×768@75Hz	60.023	75.0286	78.75	○	○	○	○
	1024×768@100Hz	148.099	99.9995	402.83	×	×	○	○
	1024×768@120Hz	182.997	119.998	497.75	○	○	×	×
		178.784	119.989	486.29	×	×	○	○
	1024×768@144Hz	213.264	144	580.08	○	○	○	○
	1024×768@165Hz	244.364	164.999	664.67	×	×	○	○

Mode	Resolution	H. Frequency (kHz)	Frame Rate (Hz)	Pixel Clock (MHz)	Port			
					HDMI1 Input	HDMI2 Input	DP1 Input	Type-C Input
WXGA+	1440×900@60Hz	55.935	59.8874	106.50	○	○	○	○
	1440×900@120Hz	182.997	119.998	497.75	○	○	×	×
		178.784	119.989	486.29	×	×	○	○
	1440×900@144Hz	213.264	144	580.08	○	○	○	○
	1440×900@165Hz	244.364	164.999	664.67	×	×	○	○
	1600×900@60Hz	60	60	108	○	○	×	×
		75	60	162	×	×	○	○
	1600×900@100Hz	148.099	99.9995	402.83	×	×	○	○
	1600×900@120Hz	182.997	119.998	497.75	○	○	×	×
		178.784	119.989	486.29	×	×	○	○
	1600×900@144Hz	213.264	144	580.08	○	○	○	○
	1600×900@165Hz	244.364	164.999	664.67	×	×	○	○
	1600×1200@60Hz	88.787	59.9506	241.5	○	○	×	×
		75	60	162	×	×	○	○
	1600×1200@100Hz	148.099	99.9995	402.83	×	×	○	○
	1600×1200@120Hz	182.997	119.998	497.75	○	○	×	×
178.784		119.989	486.29	×	×	○	○	
1600×1200@144Hz	213.264	144	580.08	○	○	○	○	
1600×1200@165Hz	244.364	164.999	664.67	×	×	○	○	
WSXGA+	1680×1050@60Hz	65.29	59.9543	146.25	○	○	○	○
	1680×1050@100Hz	148.099	99.9995	402.83	×	×	○	○
	1680×1050@120Hz	182.997	119.998	497.75	○	○	×	×
		178.784	119.989	486.29	×	×	○	○
	1680×1050@144Hz	213.264	144	580.08	○	○	○	○
	1680×1050@165Hz	244.364	164.999	664.67	×	×	○	○
FHD	1920×1080@25Hz (Interlaced)	28.125	25	74.25	×	×	○	○
	1920×1080@25Hz	28.125	25	74.25	×	×	○	○
	1920×1080@29Hz (Interlaced)	33.714	29.9677	74.17	○	○	○	○
	1920×1080@29Hz	33.714	29.9677	74.17	×	×	○	○
	1920×1080@30Hz (Interlaced)	33.75	30	74.25	○	○	○	○
	1920×1080@30Hz	33.75	30	74.25	×	×	○	○
	1920×1080@50Hz	56.25	50	148.5	○	○	○	○
	1920×1080@59Hz	67.432	59.9394	148.35	○	○	○	○
	1920×1080@60Hz	67.5	60	148.5	○	○	○	○
	1920×1080@100Hz	148.099	99.9995	402.83	×	×	○	○
135		120	297	○	○	×	×	
1920×1080@120Hz	137.259	119.982	285.5	×	×	○	○	

Mode	Resolution	H. Frequency (kHz)	Frame Rate (Hz)	Pixel Clock (MHz)	Port			
					HDMI1 Input	HDMI2 Input	DP1 Input	Type-C Input
FHD	1920×1080@144Hz	159.976	143.993	332.75	○	○	×	×
		213.264	144	580.08	×	×	○	○
	1920×1080@165Hz	244.364	164.999	664.67	×	×	○	○
	1920×1200@60Hz	88.787	59.9506	241.5	○	○	○	○
	1920×1200@100Hz	148.099	99.9995	402.83	×	×	○	○
	1920×1200@120Hz	182.997	119.998	497.75	○	○	×	×
		178.784	119.989	486.29	×	×	○	○
	1920×1200@144Hz	213.264	144	580.08	○	○	○	○
	1920×1200@165Hz	244.364	164.999	664.67	×	×	○	○
	2048×1536@29Hz	67.432	29.9697	296.7	×	×	○	○
	2048×1536@30Hz	67.5	30	297	×	×	○	○
	2048×1536@50Hz	112.5	50	594	×	×	○	○
	2048×1536@59Hz	134.864	59.9394	593.4	×	×	○	○
	2048×1536@60Hz	135	60	594	×	×	○	○
	2560×1440@60Hz	88.787	59.9506	241.5	○	○	○	○
	2560×1440@100Hz	148.099	99.9995	402.83	×	×	○	○
	2560×1440@120Hz	182.997	119.998	497.75	○	○	×	×
		178.784	119.989	486.29	×	×	○	○
	2560×1440@144Hz	213.264	144	580.08	○	○	○	○
	2560×1440@165Hz	244.364	164.999	664.67	×	×	○	○

[Video Timing]

Video ID Code	Formats	Aspect Ratio	Field Rate (Hz)	Horizontal (kHz)	Vertical (Hz)	Pixel Clock (MHz)	H-Total	V-Total
1	640x480p	4:3	59.94	31.469	59.94	25.175	800	525
			60	31.500	60.00	25.200	800	525
2	720x480p	4:3	60	31.469	59.94	27.000	858	525
3	720x480p	16:9	60	31.469	60	27.000	858	525
4	1280x720p	16:9	59.94	44.955	59.94	74.176	1650	750
			60	45.000	60.00	74.250	1650	750
16	1920x1080p	16:9	59.94	67.433	59.94	148.352	2200	1125
			60	67.500	60.00	148.500	2200	1125
18	720x576p	16:9	50	31.25	50	27.000	864	652
19	1280x720p	16:9	50	37.5	50	74.250	1980	750
31	1920x1080p	16:9	50	67.500	60	148.500	2200	1125
63	1920x1080p	16:9	120	135	120	297	2200	1125
93	3840x2160p	16:9	24	54	24	297	5500	2250
94	3840x2160p	16:9	25	56.250	25	297	5280	2250
95	3840x2160p	16:9	30	67.500	30	297	4400	2250
96	3840x2160p	16:9	50	112.5	50	594	5280	2250
97	3840x2160p	16:9	60	135	60	594	4400	2250
			59.94	135	60	594	4400	2250

Product Outline Dimensions

